

Analog Discovery Studio Datasheet

A Portable Circuits Laboratory for Every Student

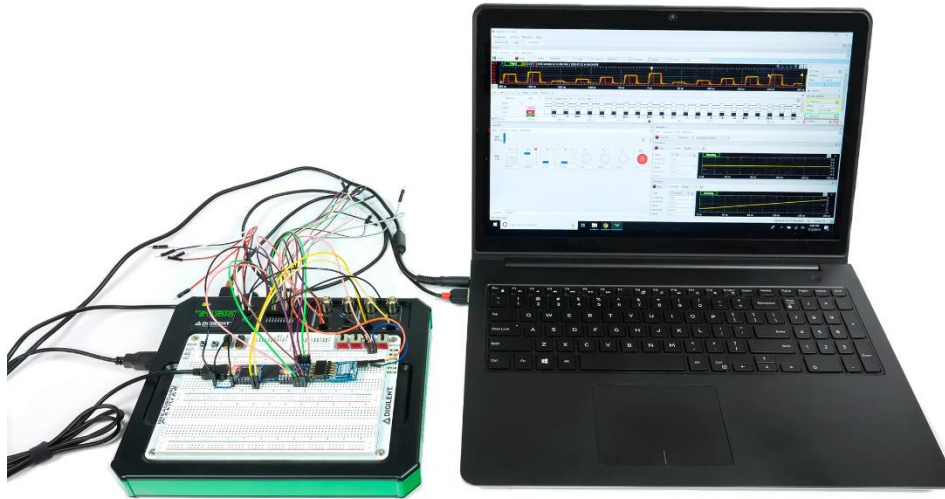

Highlighted Features

- USB-based Mixed Signal Oscilloscope
- Variety of Canvases for a variety of coursework
- BNC connectors or MTE cables for both input and output
- Two analog inputs – 30+ MHz bandwidth
- Two analog outputs – 8+ MHz bandwidth
- 16 digital input/output channels
- Sample rates up to 100 MS/s
- Variable and fixed power supply rails, including ± 12 V supplies
- Extensive software support with WaveForms, WaveForms SDK, LabVIEW, MATLAB

Overview

The Analog Discovery Studio (ADS) is a fully functional, portable test and measurement device that can turn any cross-functional space into a pop-up electronics laboratory. Equipped with 13 instruments, including an Oscilloscope, Logic Analyzer, Spectrum Analyzer, Waveform Generator, and more; the Analog Discovery Studio replaces an entire lab of individual instruments with a convenient interface and brings instrumentation to every student's desk.

Removable and replaceable Canvases enable sharing of a single device among many students in the same lab – a student can take their canvas home to build and prototype their circuits before the day of the lab. A breadboard canvas is included with every ADS while others are sold separately. Different canvases offer different learning opportunities – offerings include those with substantial breadboardable space, through-hole and surface-mount solderable surfaces for prototyping, various digital components, and even the ability to mount an FPGA development board for mixed-signal – analog and digital – coursework.

1 Features

Analog Inputs

- Two input channels with 14-bit resolution and ± 25 V input range
- Switchable between high bandwidth BNC or differential MTE connector
- 30+ MHz bandwidth with scope probes, 100 MS/s per channel

Analog Output

- Two BNC and MTE output channels with 14-bit resolution, ± 5 V output range
- 8 MHz bandwidth, 100 MS/s per channel

Digital I/O

- 16 dynamically configurable digital input/output channels
- 3.3 V or 1.8 V CMOS input, 3.3 V CMOS output
- 100 MS/s per channel

Power Supplies

- Two programmable power supplies: 1 V to 5 V and -1 V to -5 V; up to 700 mA or 2.1 W per channel
- Four fixed power supplies: 12 V (200 mA), -12 V (200 mA), 5 V (1 A), and 3.3 V (1 A)

Additional Features

- Supports swappable Canvases for multiple convenient prototyping and ready-made solutions
- An integrated USB hub to directly power, interface with, and debug downstream systems
- Advanced triggering and cross triggering between instruments and devices

Software Support

- WaveForms, Digilent's free software application for Windows, Mac, and Linux
- WaveForms SDK for custom applications and scripting through C/C++, Python, C#, Visual Basic
- LabVIEW and MATLAB support

Callout Diagrams

Analog Discovery Studio

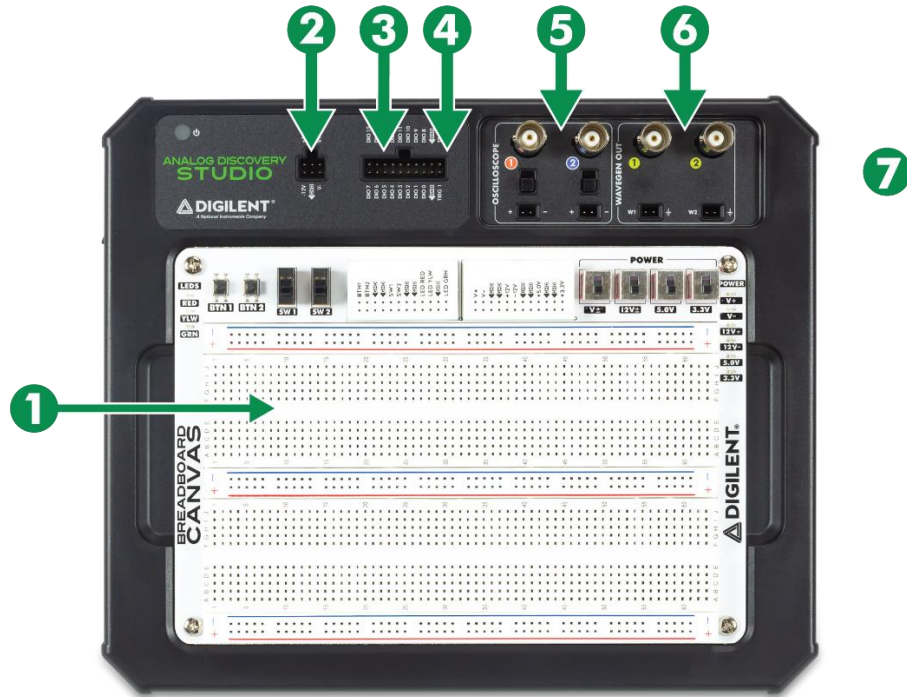

1. Included Breadboard Canvas
2. Power Supplies
3. Logic Analyzer and Pattern Generator
4. Triggers
5. Oscilloscope
6. Waveform Generator
7. Additional Software Instruments
 - a. Network Analyzer
 - b. Spectrum Analyzer
 - c. Voltmeter
 - d. Impedance Analyzer
 - e. Data Logger
 - f. Protocol Analyzer
 - g. Virtual I/O

Breadboard Canvas

The Breadboard Canvas adds a large breadboard surface, access to Analog Discovery Studio power supplies, and a variety of common devices like switches, buttons, and LEDs to the Analog Discovery Studio.

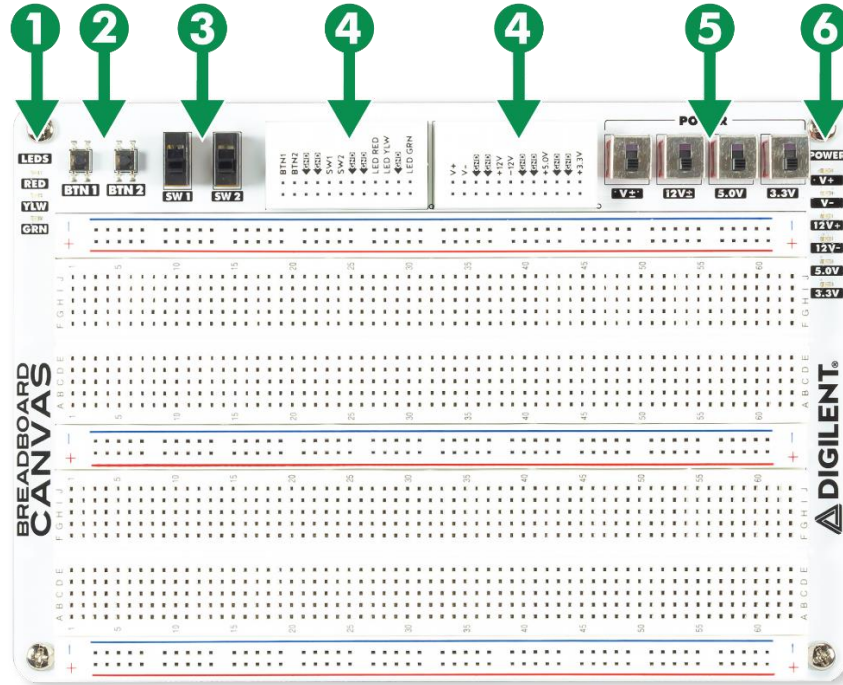

1. Three User LEDs.
2. Two User Buttons.
3. Two User Switches.
4. Two 24-pin mini-breadboards providing access to power supplies and user I/O.
5. Four switches to enable power supplies from the Analog Discovery Studio.
6. Six LED indicators for each power supply.

Blank Canvas

The Blank Canvas adds a large prototyping surface, power supply breakouts, and a variety of IC breakouts, all solderable, to the Analog Discovery Studio.

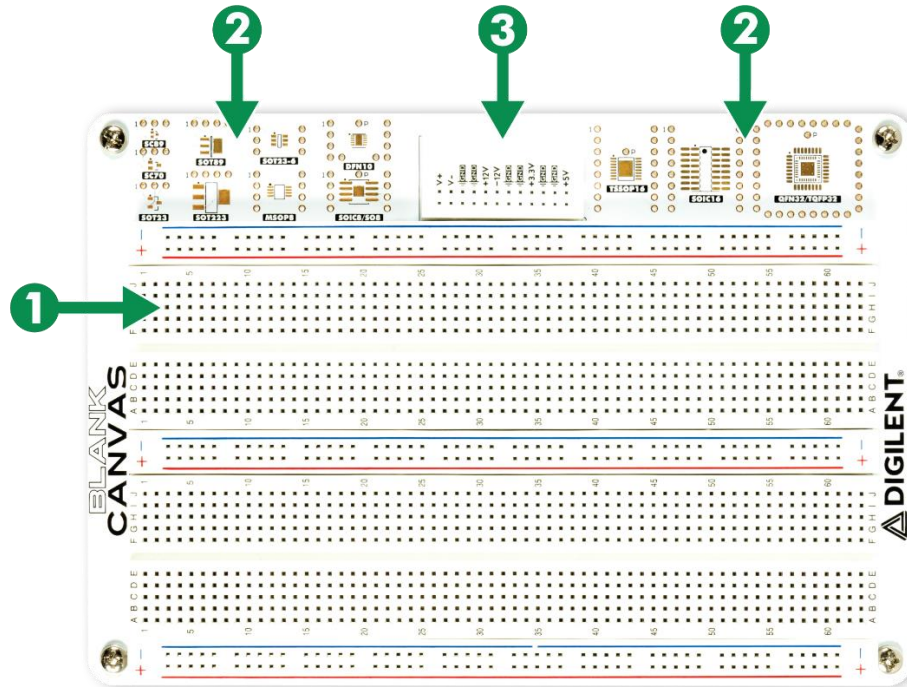

1. Prototyping Surface with three sets of power rails (included breadboards can be attached to the surface).
2. Through-hole breakouts for a variety of common surface mount component footprints.
3. Access to each of the Analog Discovery Studio power supplies.

Analog Discovery Canvas

The Analog Discovery Canvas provides the ability for the same canvas to be used with both an Analog Discovery Studio and an Analog Discovery 3. This is ideal in the situation that a student has an Analog Discovery 2 or 3 at home and access to an Analog Discovery Studio for use in a lab environment. It lets students easily switch designs between devices without having to rewire or reassemble anything. The Analog Discovery Canvas provides two full solderless breadboards with access pins to inputs and outputs, six LEDs for power supply indication, four power switches, and 2-pin headers for the analog input and output signals (1+, 2+, W1, W2).

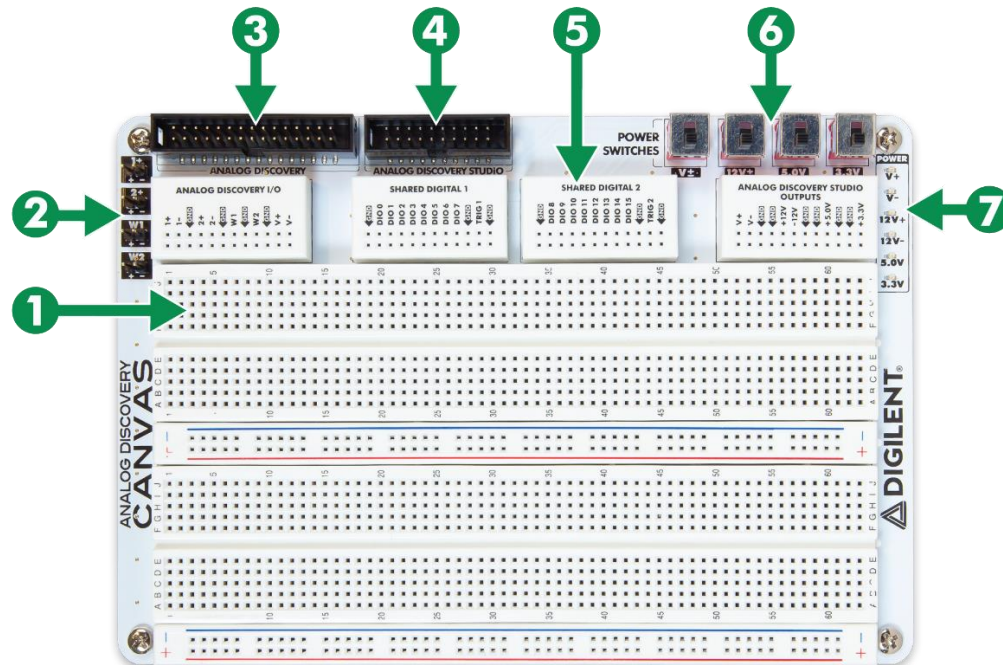

1. Two full solderless breadboards.
2. Dedicated two-pin headers for oscilloscope and waveform generator signals.
3. A 2x15 header for connecting to an Analog Discovery 2 or 3.
4. A 2x10 header for connecting to an Analog Discovery Studio.
5. Four solderless breadboards with access pins to inputs and outputs.
6. Four power switches.
7. Six LEDs for power supply indication.

FPGA Board Adapter Canvas

The FPGA Board Adapter Canvas (formerly the Interposer Canvas) allows you to use your Analog Discovery Studio to power an FPGA board through the USB port connected to the built-in USB hub. Mounting posts with appropriate spacing for use with the Nexys A7, Arty (A7, S7, or Z7), Zybo Z7, and Basys 3 are available.

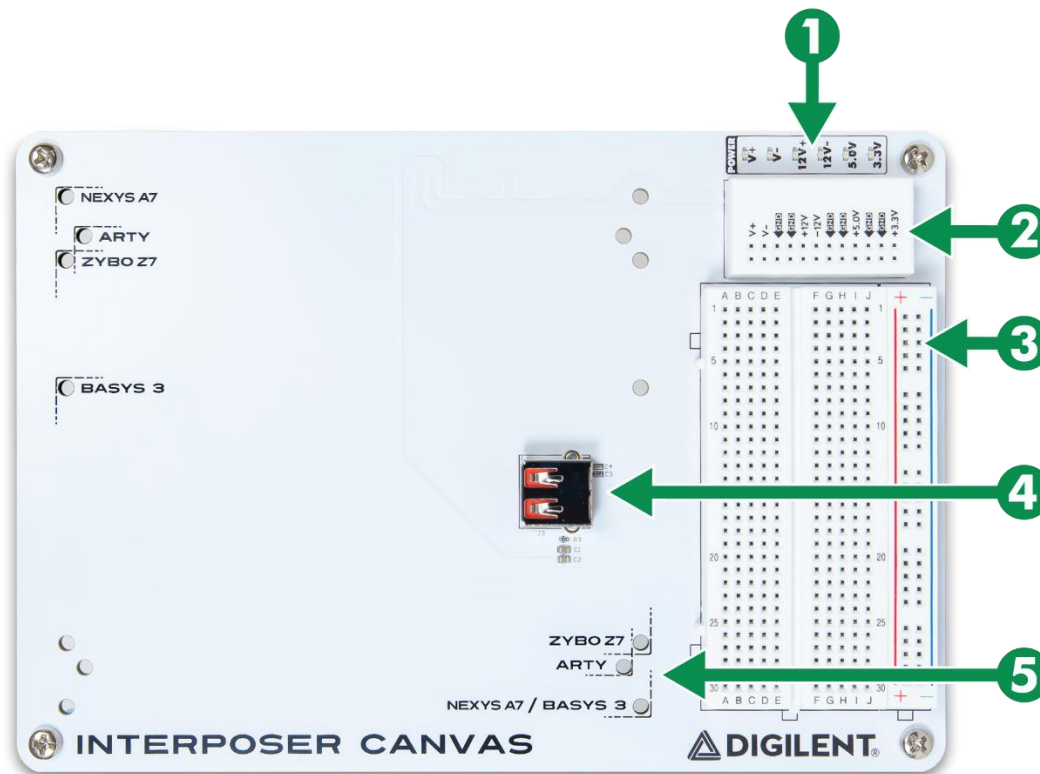

1. Six green LED power supply indicators.
2. One 24-tie-point breadboard for power supplies contact points.
3. One solderless breadboard and power supply rail.
4. USB type A slot to connect FPGA board.
5. Mounting holes for different FPGA boards.

Digital Trainer Canvas

The Digital Trainer Canvas adds a large breadboard surface and a large number of common digital components, like switches and LEDs, to the Analog Discovery Studio. Digital components can be used with 3.3 V and 5 V compatible signals, allowing the canvas to be easily interfaced with external hardware conforming to various logic standards.

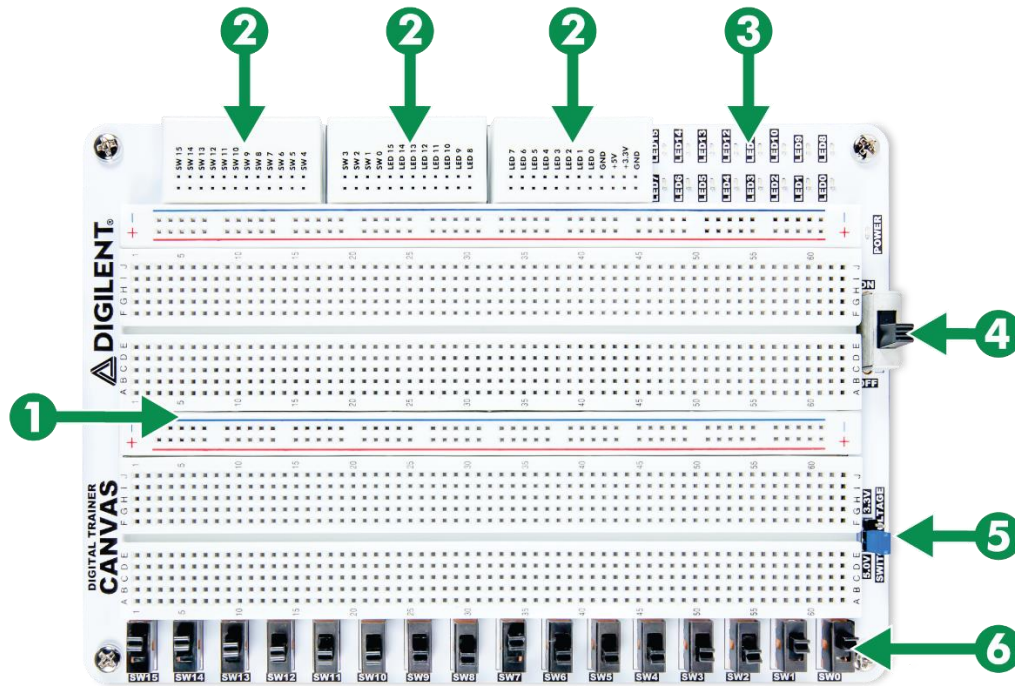

1. Two full solderless breadboards with voltage rails.
2. Three 24 tie-point boards containing power supplies, ground, switch output, and LED input contact points.
3. Sixteen user LEDs.
4. Canvas power switch.
5. Voltage level selector jumper for user switches.
6. Sixteen user switches.

2 WaveForms Software

Digilent's free WaveForms software offers a unified device experience across all our Test and Measurement devices, enabling use of all hardware features and instruments. It features a friendly user interface that has the feel of traditional benchtop devices. WaveForms makes it easy to acquire, visualize, store, analyze, produce, and reuse both analog and digital signals simultaneously.

For even more customization potential, the free WaveForms Software Development Kit (SDK) can be used to create custom applications and scripts to control the T&M device in Python, C, and additional languages.

WaveForms is Windows, Mac, and Linux compatible.

2.1 Oscilloscope

The Oscilloscope instrument captures analog input data via the analog input scope channels. When this instrument is used, the Analog Discovery Studio's analog input channels act as a two channel, 14-bit, 100 MS/s oscilloscope. Multiple sample and triggering modes are supported.

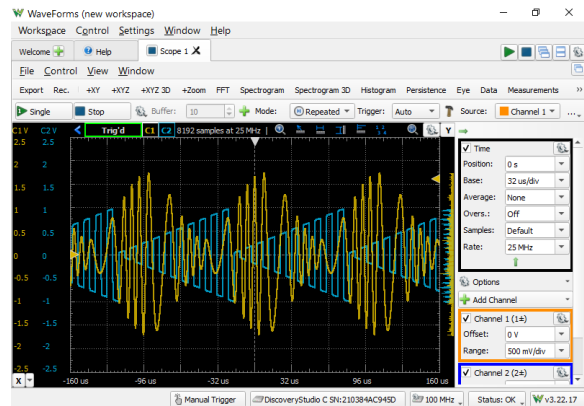

2.2 Waveform Generator

The Waveform Generator instrument can output analog voltage waveforms. The instrument supports everything from simple waveforms like Sine and Triangle waves, up to more complicated functions like AM and FM modulation. Custom sets of samples can be defined by the user in applications like Excel and imported to WaveForms.

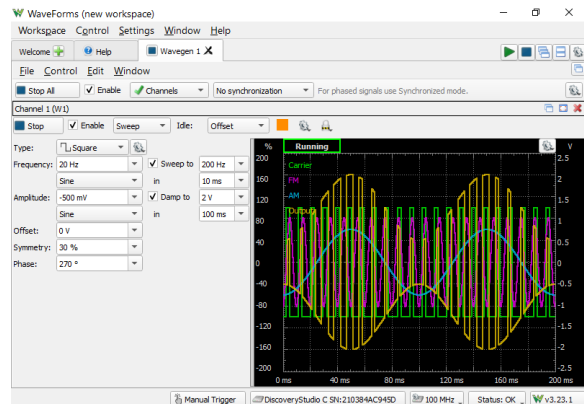

2.3 Power Supplies

The Analog Discovery Studio has two variable power supply rails that can be used to power circuits under test at up to 2.1 W per channel. These rails can be set to voltage levels between 1 V to 5 V and -1 V to -5 V.

Fixed +12 V, -12 V, 5 V, and 3.3 V rails are also available, but are not controlled from software.

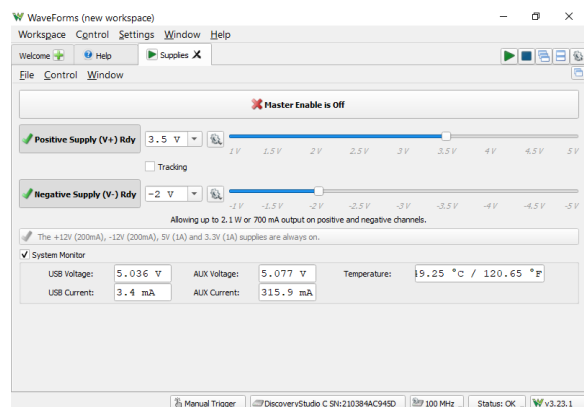

2.4 Voltmeter

The Analog Discovery Studio's analog input pins can be used with WaveForms' Voltmeter instrument to act as a simple voltmeter. DC voltages, AC RMS voltages, and True RMS voltages can be viewed for each of the two Scope channels.

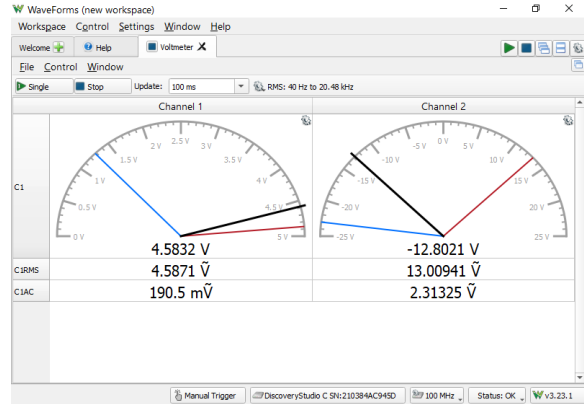

2.5 Data Logger

The Data Logger instrument can capture large buffers of analog input data on the Scope pins. The Data Logger can capture buffers of data at update rates of up to 1000 samples per second. The maximum duration of a log is dependent on the update rate, but at the extreme, can run for over a thousand hours.

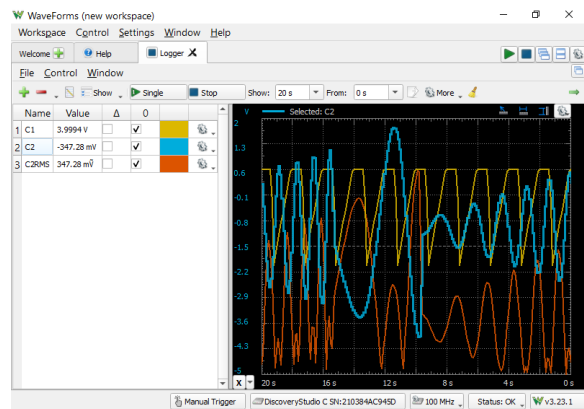

2.6 Logic Analyzer

With the Logic Analyzer, the 16 digital input/output channels are configured to capture high/low logic states. These channels are capable of interfacing with 3.3 V and 1.8 V CMOS logic signals and are tolerant to voltages of up to 5 V.

Individual input/output channels can be grouped as buses and protocols. Protocol groups can be used to view the decoded contents of packets of many common communications protocols, including SPI, I2C, UART, CAN, and I2S.

Signal states, decoded bus values, and decoded protocols can be used to trigger a Logic Analyzer capture. Protocol triggers include protocol-specific events, like start-of-transmission, end-of-transmission, or packet contents matching a user-specified value.

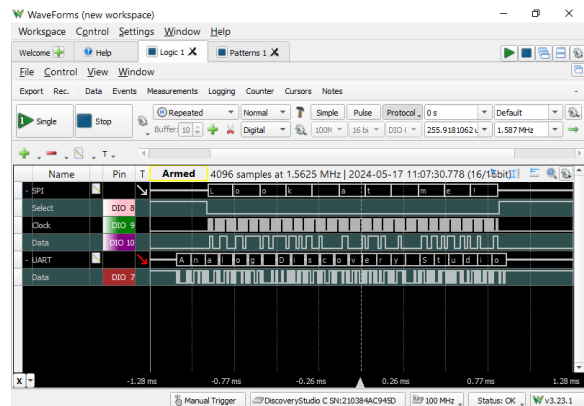

2.7 Pattern Generator

The Pattern Generator can generate logic signal sequences on the digital input/output pins. The pins can be configured to be push/pull, open drain, open source, or three-state logic. Sample rates can go as high as 100 MS/s.

Various patterns can be generated, including clocks, random signals, multiple counter types, and fully custom digital data. ROM logic can map digital input pins to digital outputs, using user-defined truth tables.

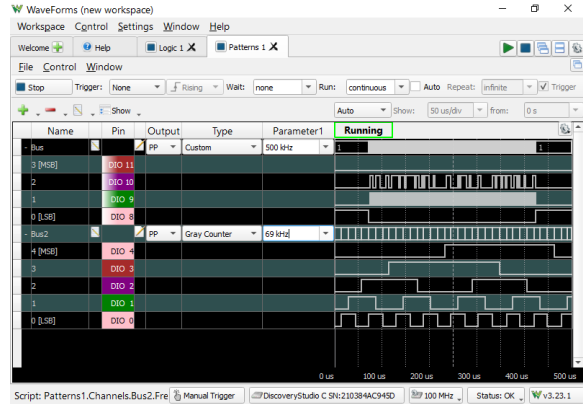

2.8 Static I/O

The Static I/O instrument can emulate a variety of user input/output devices on the digital input/output pins. Virtual LEDs, buttons, switches, sliders, and displays can be assigned to specific digital I/O pins and interacted with within the WaveForms user interface.

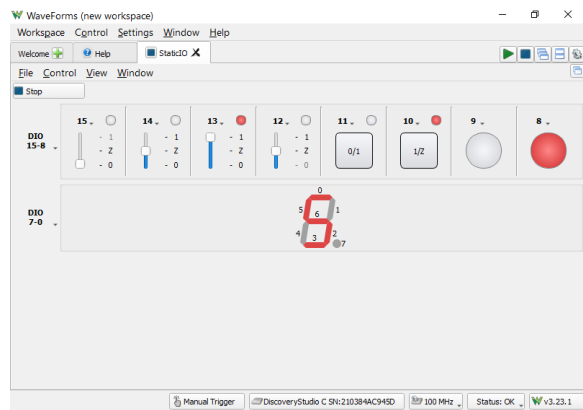

2.9 Spectrum Analyzer

The Spectrum Analyzer instrument is used to view the power of frequency-domain components of analog signals captured on the analog input channels. Cursors and automatic measurements include noise floor, SFDR, SNR, THD and more.

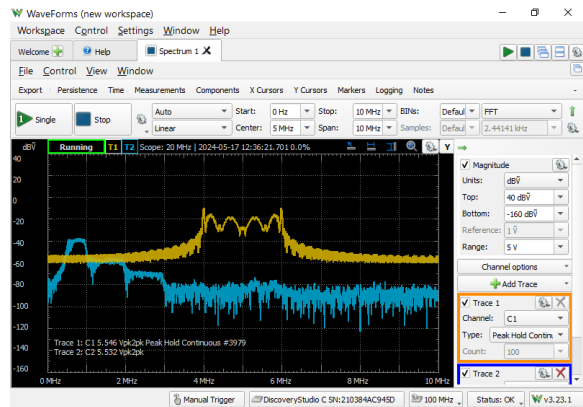

2.10 Network Analyzer

The Network Analyzer instrument can be used to view the amplitude and phase response of a circuit under test. Bode, Nichols, and Nyquist plots can also be viewed with this instrument. The Network Analyzer instrument uses the analog output and analog input channels of the Analog Discovery Studio to probe a test circuit, by generating a frequency sweep and measuring the circuit's response. The Network Analyzer can be configured to use an external signal to provide input to the circuit under test, rather than using the analog output channels.

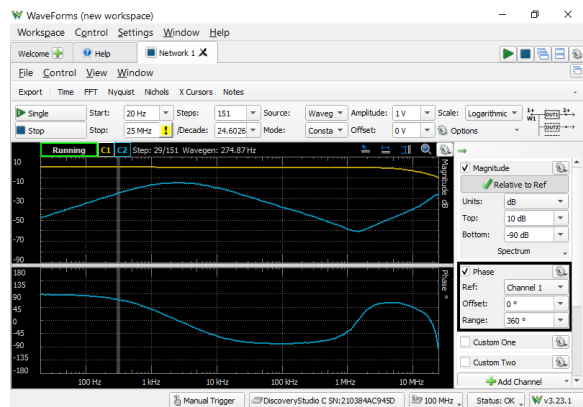

2.11 Impedance Analyzer

The Impedance Analyzer instrument is used to view a wide variety of frequency response characteristics of a circuit under test. Input, Phase, Voltage, Current, Impedance, Admittance, Inductance, Factor, and Nyquist plots are all available. In addition, Custom plots can be used to present the results of a wide variety of different mathematical operations on buffered data.

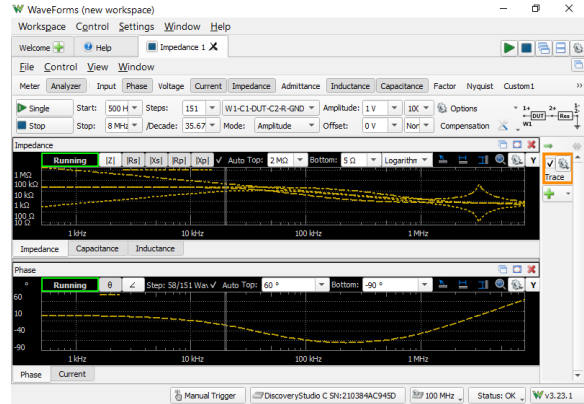

2.12 Protocol Analyzer

The Protocol Analyzer instrument generates and analyzes common communications protocols. UART, SPI, I2C, CAN, and various other kinds of transactions can be received, transmitted, and/or spied upon (depending on the protocol) by the Analog Discovery Studio using any of the digital input/output channels. Custom scripts can be written within the Protocol Analyzer instrument to generate sequences of SPI or I2C transactions.

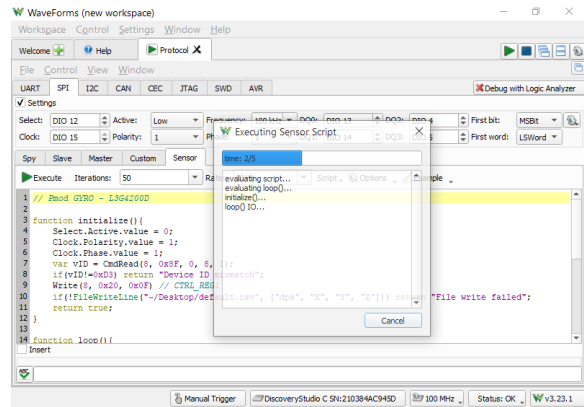

2.13 WaveForms Script Editor

Each of WaveForms' instruments can be controlled through scripts within the WaveForms application itself. WaveForms' "Script" instrument allows the user to write and run JavaScript code that can control the rest of the application through an extensive API. This allows the user to configure and run many instruments at the same time, in an easily repeatable way.

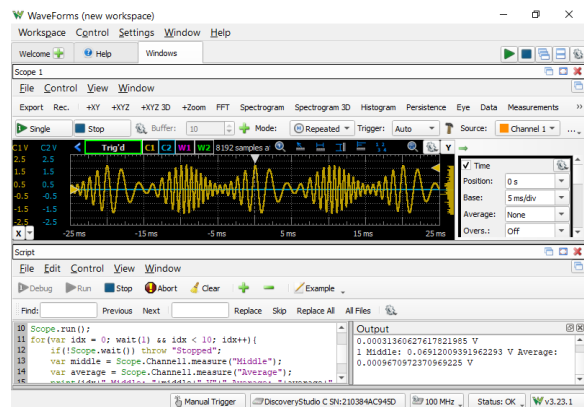

3 Extended Software Support

Digilent has created packages for both LabVIEW and MATLAB to provide users with flexibility in the environment used for both data acquisition and subsequent analysis. Each offering provides a curated experience for users that are more familiar with those applications. Further customization and control of the Analog Discovery Studio can be done through Digilent's WaveForms SDK, letting users create their own applications in C/C++, Python, C#, and Visual Basic.

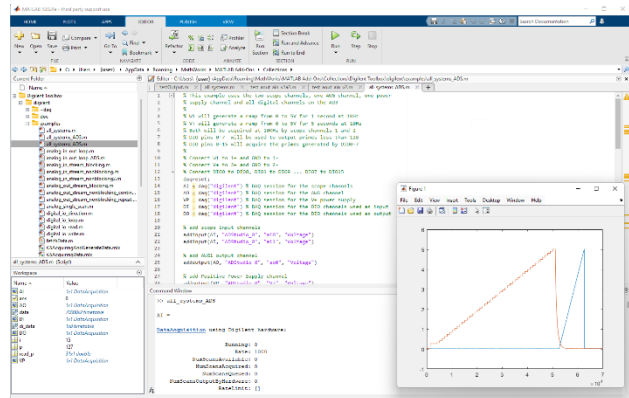
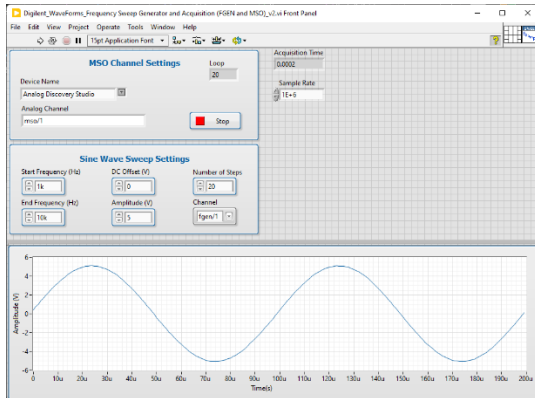

4 Analog Discovery Studio Specifications

These specifications are typical unless otherwise stated and are valid following 30 minutes of warm-up at 25 °C unless otherwise noted. WaveForms was used to determine these specifications.

4.1 Mixed Signal Oscilloscope

Analog Input Channels

Supports the Oscilloscope, Voltmeter, Data Logger, Spectrum Analyzer, Network Analyzer, Impedance Analyzer, and Script Editor instruments.

Vertical System

Number of Channels	Two	
Input Type	Single-ended	Differential
Connector Type	BNC	MTE
Input Range	±2.5 V with respect to ground (5 V peak-to-peak) ±25 V with respect to ground (50 V peak-to-peak)	
Resolution	14 bits, 13-bit noise ¹	
Absolute Resolution²	0.32 mV (scale ≤ 0.5 V/div) 3.58 mV (scale > 0.5 V/div)	
Accuracy	±10 mV ± 0.5% (scale ≤ 0.5 V/div, $V_{inCM} = 0$ V) ±100 mV ± 0.5% (scale > 0.5 V/div, $V_{inCM} = 0$ V)	
Bandwidth	30+ MHz @ -3 dB, 15 MHz @ -0.5 dB, 6 MHz @ -0.1 dB ³	9 MHz @ -3 dB, 2.9 MHz @ -0.5 dB, 0.8 MHz @ -0.1 dB
Input Impedance	1 MΩ 24 pF	
Input Coupling	DC	
Vertical Sensitivity (range)	200 μV/div to 5 V/div (10 divisions) ⁴	
CMMR	±0.5% (typical)	
Acquisition Modes	average, decimate, min/max, full scale, record	
Overvoltage Protection	±50 V _{DC} or ±30 V _{RMS}	

DC Offset Range

Range	Full Scale	Offset	Offset Accuracy
Low range (≤0.5 V/div)	5 V peak-to-peak	±2.5 V	±10 mV ±0.5%
High range (>0.5 V/div)	50 V peak-to-peak	±25 V	±100 mV ±0.5%

Horizontal System

Maximum Sample Rate	100 MS/s per channel
Buffer Size	Up to 16,384 samples per channel ⁵
Noise Buffer	Up to 1,024 samples ⁵

The above horizontal system specifications apply to Repeated/Shift/Screen modes. Record mode allows streaming acquisition data into host computer RAM at up to ~4 MS/s total, or to a file on the host computer disk at up to ~2 MS/s total. Achievable sample rates and recording lengths depend on host computer specifications.

¹ A separate small buffer to collect maximum and minimum samples when the sample rate is slower than the system frequency and is represented within WaveForms as noise.

² Ideal values based on hardware design ranges of 5.3 V and 58.6 V. Actual values may vary slightly due to component variations and are accounted for during factory calibration. WaveForms only exposes nominal ranges of 5 V and 50 V.

³ When using a connector with the appropriate frequency response.

⁴ Divisions in this context are the ten horizontal strips in the Analog Input graph windows within WaveForms. Vertical sensitivity specifies the height of one strip in the plot.

⁵ Different preset buffer sizes can be chosen based on device configuration within the WaveForms Device Manager. See the [Device Configurations](#) section of this document for more info.

Digital Channels

Supports the Logic Analyzer, Pattern Generator, Static I/O, Protocol Analyzer, Oscilloscope, and Script Editor instruments.

Vertical System

Number of Channels	16	
Connector	100 mil 2×10 MTE Header	
Function Control	Individually programmable as Digital I/O, Logic Analyzer, Pattern Generator, or Protocol	
Input Voltage	0 V to 3.3 V (5 V tolerant)	
Input Type	LVCMOS (1.8 V or 3.3 V, 5 V tolerant) ¹	
Input Logic Level	1.8 V CMOS ¹ Input Low Voltage, VIL, Min 0 V, Max 0.63 V Input High Voltage, VIH, Min 1.17 V, Max 5 V	3.3 V CMOS ¹ Input Low Voltage, VIL, Min 0 V, Max 0.8 V Input High Voltage, VIH, Min 2.0 V, Max 5 V
Output Type	LVCMOS (3.3 V)	
Output Logic Level	Output Low Voltage, VOL, Min 0 V, Max 0.5 V Output High Voltage, VOH, Min 2.4 V, Max 3.3 V	
Slew Rate	Slow	
Drive Strength	4 mA	
Hardware Pull Resistors	1 MΩ pull-down resistors	
Logic Analyzer Interpreters	SPI, I2C, UART, CAN, I2S, 1-Wire, PS/2, HDMI CEC, Manchester codes, JTAG, GPIB, SWD, custom ²	
Pattern Generator	Constant, clock, pulse, random, number, Binary counter, Gray counter, Johnson counter, Decimal counter, walking 0/1, ROM Logic, custom ²	
Custom Patterns File	Import and export custom data as *.csv, *.txt or *.tdms file	
Channel-to-Channel Skew	2 ns, typical	
Overvoltage Protection	Short-circuit to ground, ±20 V	

Horizontal System

Maximum Sampling Rate	100 MS/s per channel
Logic Analyzer Buffer Memory	Up to 16,384 samples per channel ³
Pattern Generator Buffer Memory	Up to 16,384 samples per channel ³

¹ Different preset logic level inputs can be chosen based on device configuration within the WaveForms Device Manager. See the [Device Configurations](#) section of this document for more info.

² More options may be available in the latest version of the WaveForms software.

³ Different preset buffer sizes can be chosen based on device configuration within the WaveForms Device Manager. See the [Device Configurations](#) section of this document for more info.

The above horizontal system specifications apply to Repeated/Shift/Screen modes. Record mode allows streaming acquisition data into host computer RAM at up to ~3 MS/s total, or to a file on the host computer disk at up to ~2 MS/s total. Achievable sample rates and recording lengths depend on host computer specifications.

4.2 Arbitrary Waveform Generator (Wavegen)

Supports the Waveform Generator, Network Analyzer, Impedance Analyzer, and Script Editor instruments.

Vertical System

Number of Channels	2	
Output Type	Single-ended	
Connector Type	BNC	MTE
Standard Functions	Sine, square, triangle, ramp up, ramp down, DC voltage, noise, trapezium, others	
Advanced Waveforms	Sweep, modulation (AM/FM), math, play mode, custom	
Output Voltage Range	±5 V	
Resolution	14 bits (carrier), 9 bits (AM/FM)	
Absolute Resolution	166 μV (Vout ≤ 1.25 V) 665 μV (Vout > 1.25 V)	
Accuracy	±10 mV ± 0.5% (Vout ≤ 1.25 V) ±25 mV ± 0.5% (Vout > 1.25 V)	
Output Impedance	0 Ω ¹	
Bandwidth	8 MHz @ -3 dB, 4 MHz @ -0.5 dB, 1 MHz @ -0.1 dB ²	8 MHz @ -3 dB, 2.9 MHz @ -0.5 dB, 0.8 MHz @ -0.1 dB
Sweep Modes	Frequency and Amplitude. Up and down with selectable start/stop frequencies and settable time increments	
Custom Waveform Files Supported	Import files *.csv, *.txt, *.mp3, *.wav, *.wmv & *.avi, export as image, or as raw data in *.csv, *.txt or *.tdms formats	
DC Current Drive	30 mA maximum ³	
Slew Rate	400 V/μs (10 V step)	
Overvoltage Protection	Short-circuit to ground, ±15 V	

DC Offset Range

Range	Full Scale	Offset	Offset Accuracy
Low range	2.5 V peak-to-peak	±1.25 V	±10 mV ± 0.5%
High range	10 V peak-to-peak	±5 V	±25 mV ± 0.5%

¹ Output impedance is not precisely controlled.

² When using a connector with the appropriate frequency response.

³ Maximum value for distortion-free generation. Up to 40 mA can be supplied before hardware cutoff.

Horizontal System

Maximum Sample Rate	100 MS/s per channel
Carrier Buffer Size	Up to 16,384 samples per channel ¹
AM/FM Buffer Size	Up to 2,048 samples per channel ¹

4.3 Pattern Generator

Shares digital input/output channels with Mixed Signal Oscilloscope: See the [Digital Channels](#) Specifications for characteristics.

4.4 Trigger System

Trigger Features

Trigger Sources	Oscilloscope analog channels, Arbitrary waveform generator start, Digital I/O lines, External triggers (TRIG1 / TRIG2), Manual
Trigger Modes	None, Auto, Manual (Forced Trigger), Single
Analog Trigger	Edge, pulse, transition, condition, level, hysteresis, hold-off
Digital Trigger	Edge, level, pattern, glitch
Analog/Oscilloscope Trigger Resolution	10 ns
Digital/Logic Analyzer Trigger Resolution	10 ns

External Triggers (TRIG1 / TRIG2) Characteristics

Trigger 1 and Trigger 2 are connected to two pins in the 2×10 MTE connector.

See the [Digital Channels](#) Specifications for the electrical characteristics of the External Triggers.

¹ Different preset buffer sizes can be chosen based on device configuration within the WaveForms Device Manager. See the [Device Configurations](#) section of this document for more info.

4.5 Device Configurations

The Analog Discovery Studio has several different configurations which can be applied, primarily affecting the analog input, analog output, and digital I/O buffer sizes available to the user.

Configuration	Scope Buffer Size	Wavegen Buffer Size	Logic Buffer Size	Patterns Buffer Size
1 (Default)	8 kS and 1 kS noise buffer / channel	4 kS / channel, 2 kS AM and FM buffer	4 kS / channel	1 kS / channel
2	16 kS and 1 kS noise buffer / channel	1 kS / channel, 512 S AM and FM buffer	1 kS / channel	N/A
3	2 kS and 256 S noise buffer / channel	16 kS / channel, 2 kS AM and FM buffer	N/A	N/A
4	512 S / channel	256 S / channel	16 kS / channel	16 kS / channel
5 ¹	8 kS and 1 kS noise buffer / channel	4 kS / channel, 2 kS AM and FM buffer	4 kS / channel	1 kS / channel
6	8 kS and 1 kS noise buffer / channel	4 kS / channel, 2 kS AM and FM buffer, 2 kS Power Supply control	2 kS / channel	256 S / 8 channels
7 ¹	512 S / channel	256 S / channel	16 kS / channel	16 kS / channel
8	8 kS and 512 S noise buffer / channel	1 kS / channel	16 kS / channel	256 S / 8 channels

Note: Memory sizes, including buffer sizes, specified in units like kS and MS, are rounded from equivalent binary power units, such as MiS. For example, a listed 16 kS is rounded from 16 kiS, which is 16,384 samples.

4.6 Additional Features

Spectrum Analyzer

Frequency Range	0 Hz to 30 MHz ²
Display Modes	Magnitude, average, peak hold, min hold, count
Y Axis	Logarithmic (dBV, dBu, dBm) or linear (volts)
X Axis	Linear or Logarithmic
Power Spectrum Algorithms	FFT, CZT
Windowing Functions	Rectangular, Triangular, Hamming, Hann, Cosine, Blackman-Harris, Flat Top, Kaiser

¹ In this configuration, the Digital Inputs operate at a 1.8 V CMOS logic standard. See the [Digital Channels](#) section for additional information.

² Higher frequencies up to 50 MHz can be selected within WaveForms but results may be limited by the analog input or analog output bandwidth of the hardware.

Network Analyzer

Frequency Range	20 μ Hz to 4 MHz ¹ , up to 10,001 steps
Display Modes	Magnitude, Phase
Y Axis	Linear or Logarithmic
X Axis	Linear or Logarithmic
Plots	Bode, Time, FFT, Nichols, Nyquist

Protocol Analyzer

Shares digital input/output channels with Mixed Signal Oscilloscope: See the [Digital Channels](#) Specifications for the physical characteristics.

Protocol Interpreters	UART, SPI, I2C, CAN, CEC, JTAG, SWD, AVR
Protocol Generators	UART, SPI, I2C, CAN, CEC, SWD, AVR

Impedance Analyzer

Frequency Range	20 μ Hz to 8 MHz ¹ , up to 10,001 steps
Display Modes	Magnitude, Phase
Y Axis	Linear or Logarithmic
X Axis	Linear or Logarithmic
Plots	Bode, Time, FFT, Nichols, Nyquist, Custom

Math Channels

Operations	Addition "+", Subtraction "-", Multiplication "*", Division "/", Remainder "%"
Brackets	Parenthesis "()", Square "[]"
Constants	Exp, Ln, Log, Pi
Functions	Logarithm, power, minimum, maximum, square root, sine, cos, tan, arccos, arctan, arctan2, absolute value, round, floor, ceiling
Operands	All analog and digital input channels, reference waveforms, time, constants, Pi
Custom Channels	Butterworth, Chebyshev, Lock-In Amplifier

¹ Higher frequencies up to 25 MHz can be selected within WaveForms but results may be limited by the analog input and output bandwidth of the hardware.

Programmable Power Supply

Programmable Power Supplies

Number of Channels	2
Voltage Range	1 V to 5 V, -1 V to -5 V
Current Output	Up to 700 mA or to 2.1 W per channel, whichever limit is reached first
Connector Type	Accessible as a pin in the 100 mil 2x3 MTE header and one of the Canvas pogo pins

Fixed Power Supplies

Number of Channels	4			
Voltage Range	12 V	-12 V	5 V	3.3 V
Current Output	200 mA	200 mA	1 A	1 A
Connector Type	Accessible as a pin in the 100 mil 2x3 MTE header and one of the Canvas pogo pins		Accessible through one of the Canvas pogo pins	

4.7 Connectivity

USB Hub Interfaces

Device Connector	USB 2.0 Hi-Speed Standard B ¹ labeled “DEVICE”
Host Connector	USB Standard-A for additional hub connections
Device to Canvas	USB data pins connected to a pair of pogo pins for Canvas use

Audio Interface

Audio Output	Stereo Audio Output jack connected to the analog output channels
---------------------	--

4.8 Power Requirements

The Analog Discovery Studio comes with the required external power supply.

Auxiliary Power Supply Voltage	15 V
Auxiliary Power Supply Current	2.4 A recommended
Barrel Connector Size	5.5 mm × 2.1 mm (positive inner pin)

4.9 Physical Characteristics

Dimensions	23.35 cm × 19.35 cm × 3.9 cm (L × W × H) (~9.2 in × ~7.6 in × ~1.5 in)
Weight	573 g (~20.2 oz) ²

¹ USB Standard B to USB Standard A cable included.

² With the Breadboard Canvas that is included with the Analog Discovery Studio, the total weight is 893 g (~31.5 oz)

4.10 Environmental

Ambient Operating Temperature	0 °C to 40 °C (32 °F to 104 °F)
Storage Temperature	-20 °C to 60 °C (-4 °F to 140 °F)
Operating Humidity	10% to 90% RH non-condensing
Storage Humidity	5% to 95% RH non-condensing
Pollution Degree	2
Maximum Altitude	2000 m

4.11 Certifications

See the [Analog Discovery Studio Declaration of Conformity](#) document.

5 Ordering Information and Purchasing Options

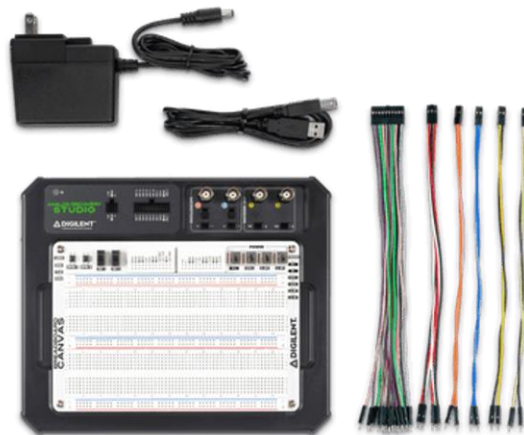

Associated Digiilent Part Numbers:

- 410-384 – Analog Discovery Studio (base purchase kit)
- 471-031 – Add two BNC Oscilloscope probes and two BNC to mini grabber probes
- 471-037 – Add two BNC Oscilloscope probes, two BNC to mini grabber probes, and a case

Material included in base purchase kit:

- One (1) Analog Discovery Studio
- One (1) Breadboard Canvas
- One (1) 15 V 2.4 A power supply
- One (1) USB A to B cable
- One (1) set of Analog Discovery Studio MTE Cables

6 Recommended Accessories

Digilent Part Number	Product
410-412	Analog Discovery Canvas
410-391	Blank Canvas
410-385	Breadboard Canvas
410-428	Digital Trainer Canvas
410-414	FPGA Board Adapter Canvas
460-004	BNC Oscilloscope x1/x10 Probes (Pair)
240-136	BNC to Minigrabber Cable ¹
240-134	BNC to Alligator Clip Cable ¹

7 Additional Resources

Reference material for the Analog Discovery Studio including a getting started guide, reference manual, specifications, and tutorials on each of the instruments within WaveForms can be found on the [Analog Discovery Studio's Resource Center](#) on Digilent's Reference site.

8 The Essential Instruments Family

Digilent's Essential Instruments family is the premier offering for engineers looking for a low barrier to entry while broadening their expertise with Test and Measurement equipment. These devices are cost-optimized for students and engineers alike, provide maximum value for minimal cost. From the Digital Discovery, a dedicated workhorse for debugging digital interfaces, to the Analog Discovery Studio, an all-in-one electronics laboratory, to the legendary Analog Discovery 2 and 3, in conjunction with Digilent's freely available WaveForms software, each device provides a solid foundation for any engineer who needs to test or debug their projects.

Analog Discovery 3

The Analog Discovery 3 is a multi-function test and measurement device, offering a digital oscilloscope, logic analyzer, waveform generator, pattern generator, and much more – all in a device that fits in the palm of your hand. Building on the foundation set by the Analog Discovery 2, the Analog Discovery 3 offers a faster and flexible sampling rate, double the memory buffer, and more robust power supplies. Using the flexible WaveForms software (supported by Windows, Mac, and Linux), the Analog Discovery 3 can be used in the lab, in the field, or even at home - you're no longer tied down to a traditional benchtop and stacks of expensive test instruments.

¹ Either BNC to Minigrabber or Alligator clip cables are recommended for analog output, as BNC Oscilloscope Probes should not be used with the AWG.

Digital Discovery

The Digital Discovery is a combination USB logic analyzer and pattern generator, featuring 24 high-speed digital inputs and 16 digital I/O channels. With a high-speed adapter, the device can sample up to 800 MS/s on up to 8 input channels. Sampling up to 100 MS/s is supported on all channels. DDR memory offers deep input buffers, with 64 MS of input buffer per high-speed input channel.

9 Analog Discovery Pro Line



Diligent's Analog Discovery Pro line is for users who are ready to go pro. With expanded feature sets not offered in Diligent's Test and Measurement Essentials line including deep memory, higher bandwidth, networking capability, and USB 3.0, an Analog Discovery Pro device has already stepped up to the challenging task ahead of you.

Devices in the Analog Discovery Pro family provide the utility of professional benchtop equipment with the flexibility of a portable instrument. The series includes mixed signal oscilloscope and programmable power supply instruments that give engineers the ability to tap into the efficiency of the WaveForms software while offering a wider selection of specifications in products created with the professional in mind. Other members of the Analog Discovery Pro family include:

Analog Discovery Pro 2000-Series

ADP2230:

- Mixed signal oscilloscope
- BNC connectors and an aluminum case
- Two analog inputs – 50+ MHz bandwidth
- One analog output – 15 MHz bandwidth
- 16 Digital I/O
- Sample rates up to 125 MS/s
- Two programmable power supply outputs
- Deep memory buffers for long acquisitions – up to 128 MS per channel for analog input
- USB 3.0 connectivity
- Dual Mode for synchronization of multiple devices

Analog Discovery Pro 3000-Series

ADP3450/ADP3250:

- Mixed signal oscilloscope
- Two or four analog inputs, two analog outputs
- 0.5 GS/s sample rate (with oversampling), per channel
- 55+ MHz bandwidth
- 16 Digital I/O
- Ethernet connectivity
- Embedded Linux Mode

Analog Discovery Pro 5000-Series

ADP5250:

- Mixed signal oscilloscope
- Two analog inputs, one analog output
- 1 GS/s sample rate shared by both analog inputs
- 100 MHz bandwidth
- 8 Digital I/O
- Dedicated Digital Multimeter and DC Power Supplies

Discovery USB-Programmable Power Supply (DPS3340)

- USB programmable power supply
- Three programmable output channels with optional waveform generator control
- 1 V to 5 V (up to 1 A), -1 V to -15 V (up to 500 mA), 1 V to 15 V (up to 500 mA)
- Integrated voltage and current readback of each channel

10 About Diligent

Diligent is committed to making engineering accessible, offering competitive pricing, portable products, and comprehensive documentation. Specializing in test and measurement devices, Xilinx-based FPGA development boards, a variety of expansion modules for customizing applications, and robust options for DAQ and datalogging, our design philosophy champions your creativity. By emphasizing speed, modularity, customizability, and world-class support, we provide the building blocks while you bring the brilliance.